

On Track To KINDERGARTEN

Question of the Week:

What kind of pet do you have or would you like to have?

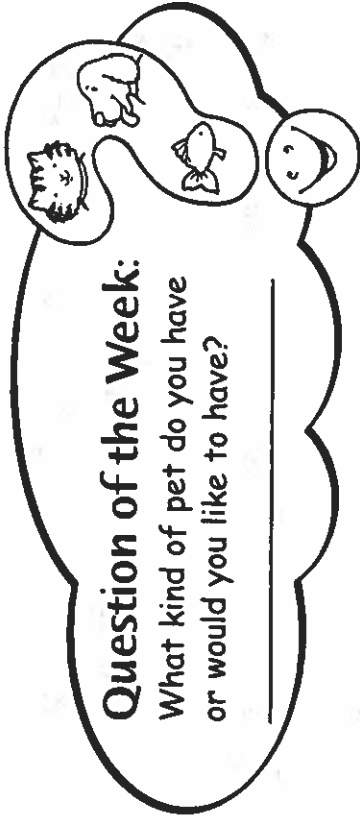

April - Week 1

 Sing BINGO. 

Play NUMBER COVER-UP.

1	2	3
4	5	6
7	8	9

Play catch with a beach or sponge ball.

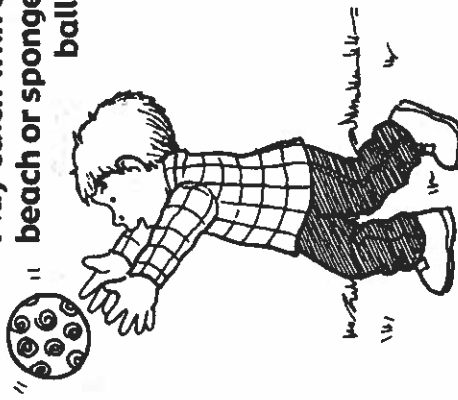

Go for a TEXTURE

WALK around your yard. Feel:

- ___ Brick
- ___ Sidewalk
- ___ Grass
- ___ Tree bark
- ___ Leaves

How do they feel?

- Bumpy?
- Smooth?
- Rough?

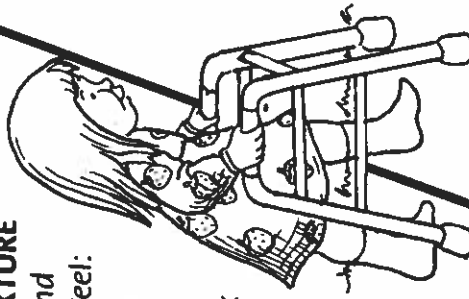
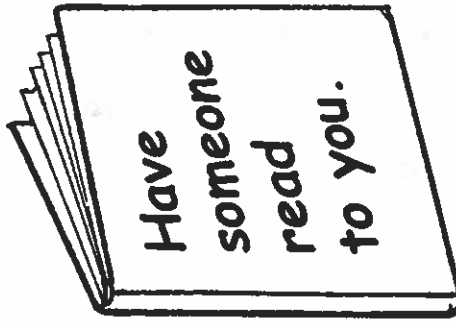

Child's Name _____

Parent's Name _____

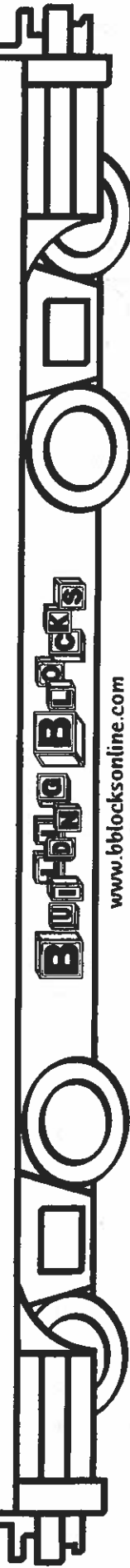

www.bbtocksonline.com

1	2	3
4	5	6
7	8	9

3	6	7
8	4	1
2	9	5

Play **NUMBER COVER-UP**. Give your child some bottle caps or buttons. Name a number and have him cover up the number on each game sheet. Play until all the numbers are covered up.

On Track To KINDERGARTEN

Question of the Week:
What vegetables do you like?

April - Week 2

Learn and recite HUMPTY DUMPTY.

Name 3 things that are:

- ___ Hot ___ Cold
- ___ Big ___ Little
- ___ Fast ___ Slow

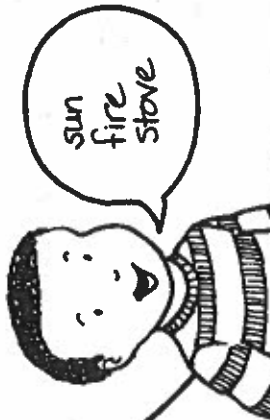

Play FOLLOW MY DIRECTIONS

Adult says:

- "Jump up and down."
- "Clap your hands."
- "Turn around."
- "Stand on one foot."

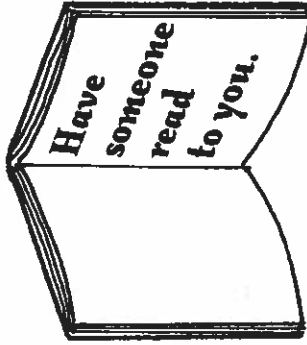
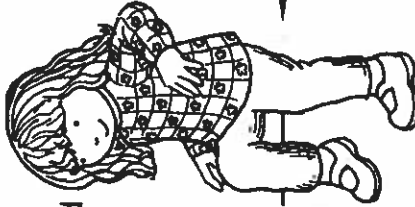

BONUS GAME

WHAT'S WRONG?



Do these
crayon
rubbings on
white paper.
___ Bricks
___ Sidewalk
___ Bark

Child's Name _____

Parent's Name _____

Blackboard Blotches

www.bblocksonline.com

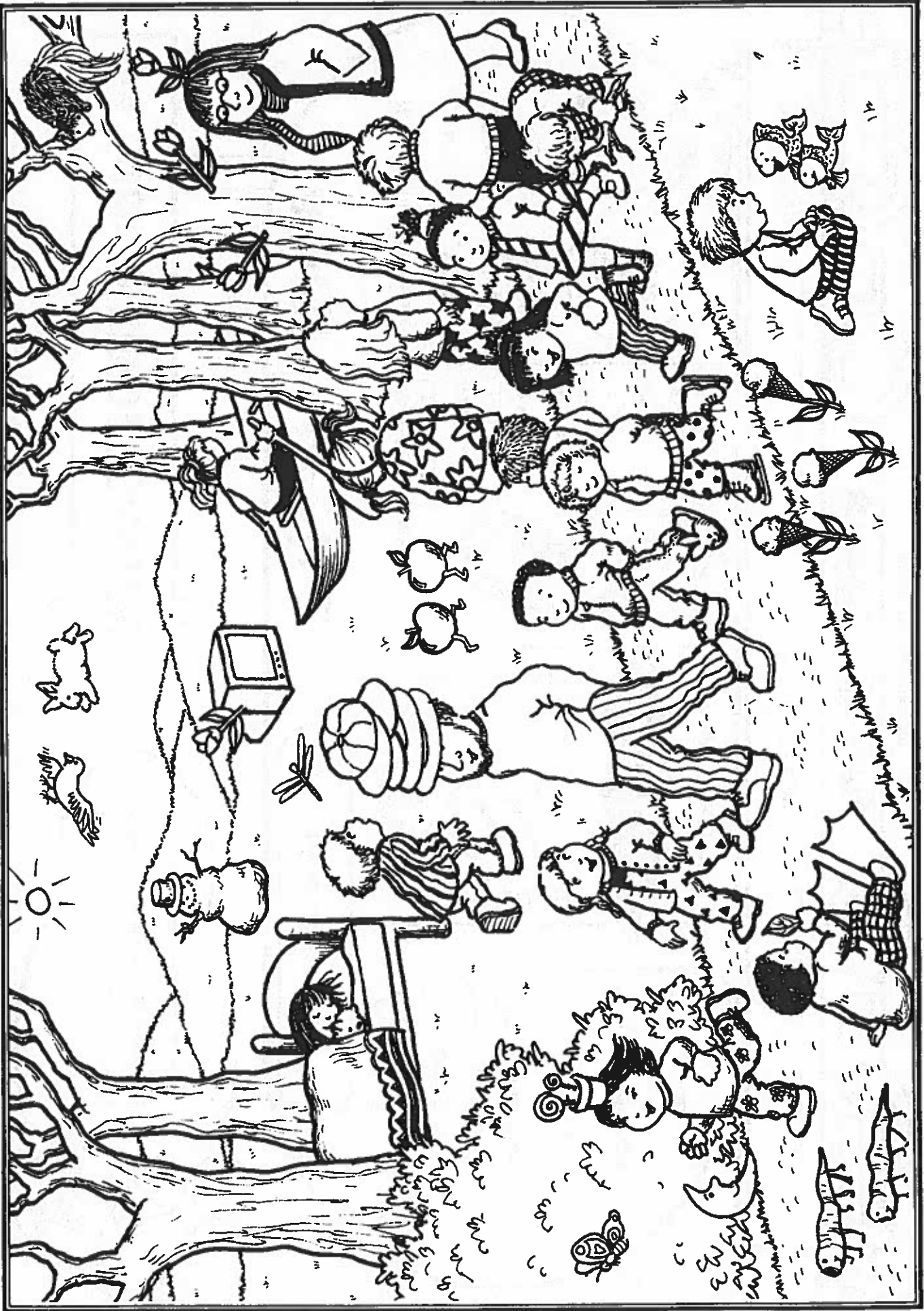

WHAT'S WRONG? Look carefully at the Spring picture and find all the things that are wrong.

On Track To KINDERGARTEN

Question of the Week:
What color flower do you like best?

April - Week 3

♪ Sing RAIN, RAIN GO AWAY ♪

Play WHAT'S MISSING?

Put several objects on a table. Have your child cover her eyes. Take one object away. Uncover her eyes.

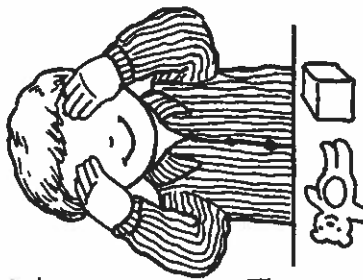

WHAT'S MISSING?

Play until all the objects are gone.

Gallop all around your yard or up and down your sidewalk.

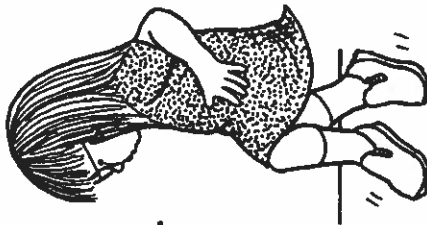

Have someone read to you.

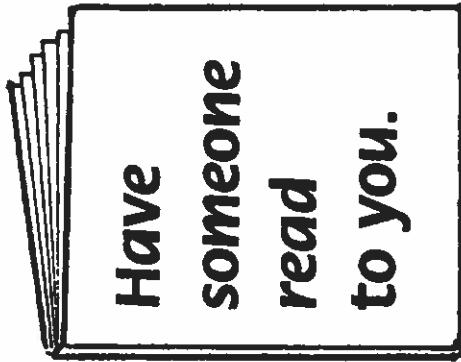

Draw and color a picture of spring flowers.

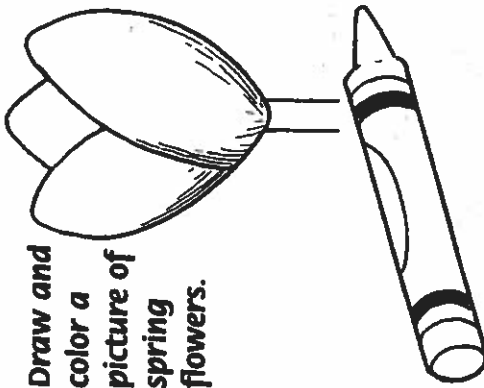

Child's Name _____

Parent's Name _____

Build For The Blocks

www.bbblocks.com



spring flowers

On Track To KINDERGARTEN

Question of the Week:

Have you ever flown in an airplane?

___ Yes ___ No

April - Week 4

 Sing OLD McDONALD. 

Show how you look when you feel:

- ___ Sad
- ___ Happy
- ___ Angry
- ___ Afraid
- ___ Sleepy
- ___ Surprised
- ___ Worried

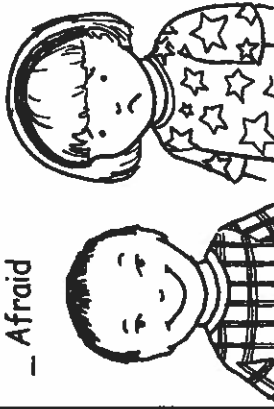

Visit a playground.
Did you go on the:

- ___ Monkey bars?
- ___ Swings?
- ___ slide?

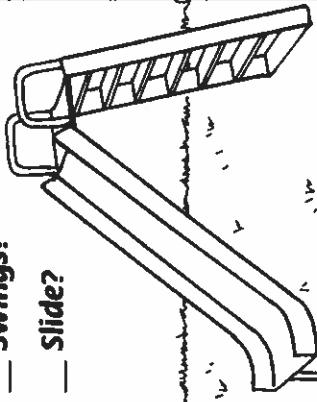

Have someone read to you.

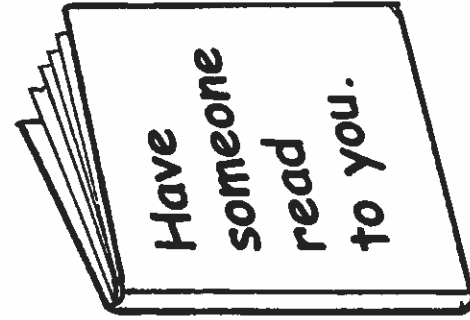

Draw a picture of a rainy day. Tell another person about it.

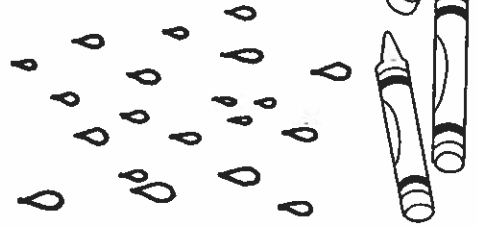

Child's Name _____

Parent's Name _____

Blueprints Books

www.bblocksonline.com

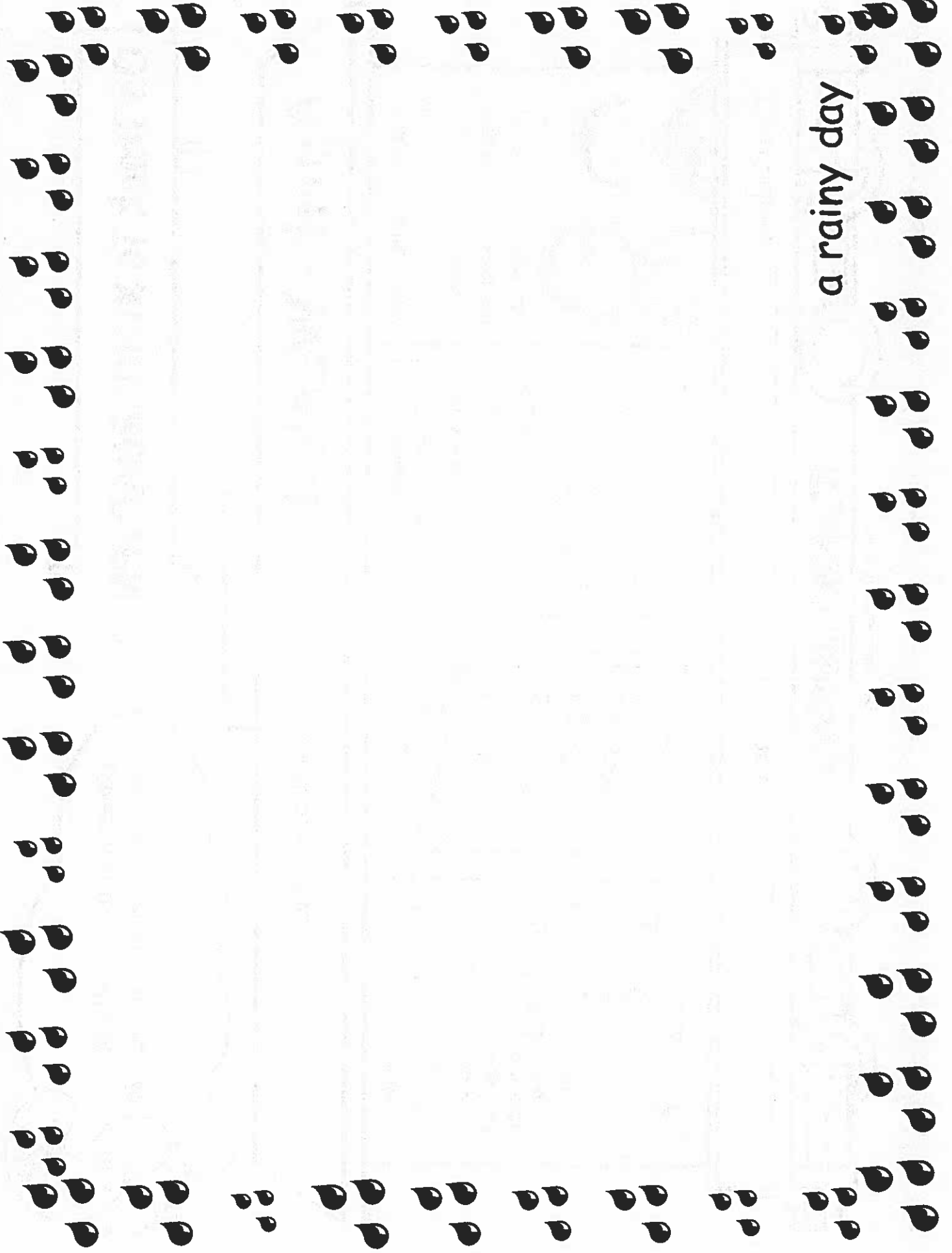

a rainy day

